

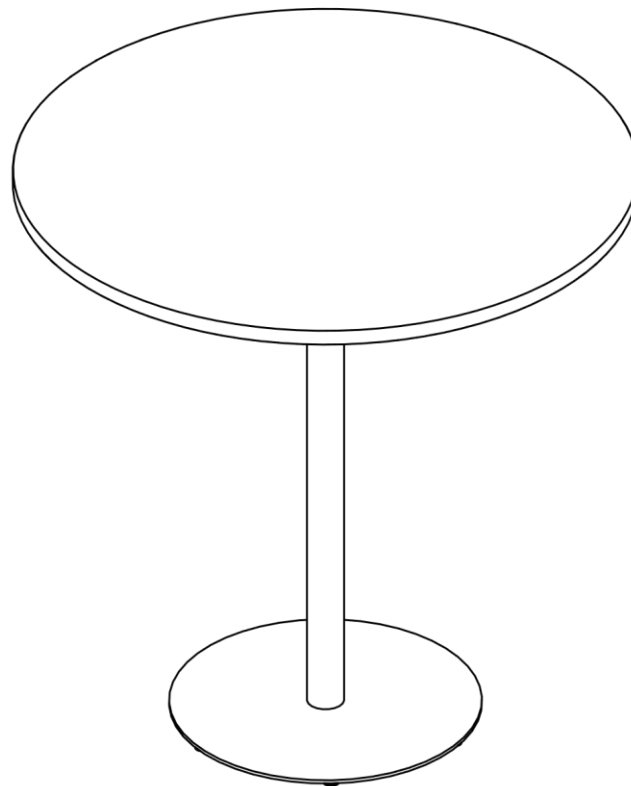







Disc Base Installation Instructions

Date	Page No.	Description of change	Name
05-04-2021	1-4	Released	S. Powers
08-24-2021	4-5	Added steps for Double Disc Base Tables	S. Powers
05-07-2024	1-7	Changed to 2-piece design	S. Powers

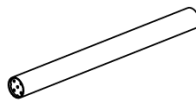

Disc Base Installation Instructions

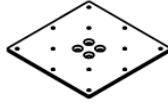
Parts List

Item	Replacement Part number	Circle Sheet Number	Description	Image
P1	WFS-DBB21	RWFS-DBB21	Disc Base Top	
P2	WFS-DB21	RWFS-DBT21-P	Disc Base Bottom	
P3	RH-SHSFU102414B	RH-SHSFU102414B	Flat Head Hex Screw #10-24 x 1/4"	
P4	RH-DISCGLIDE	RH-DISCGLIDE	#8-32 Glide	
P5	T-DBSTxx xx = 16, 29 or 42	RT-DBSTxx-P xx = 16, 29 or 42	Post Leg 16H, 29H or 42H x 60mm Dia	
P6	RH-SHF51618-1	RH-SHF51618-1	Flat Head Hex Screw 5/16-18 X 1" long	
P7	WFS-UTP	RWFS-UTP-I	Top Plate 8"x8"	
P8	RH-QS0978	RH-QS0978	Flat Head Wood Screw #9 X 7/8" long	
P9	T-UCKxx xx= 36-72 (increments of 6)	RWPS-HSxx xx= 36-72 (increments of 6")	Worksurface Stiffener (U-Channel)	

Disc Base Installation Instructions

Step 1:

Assemble the two-piece disc base using (4) #10-24 x 1/4" screws.

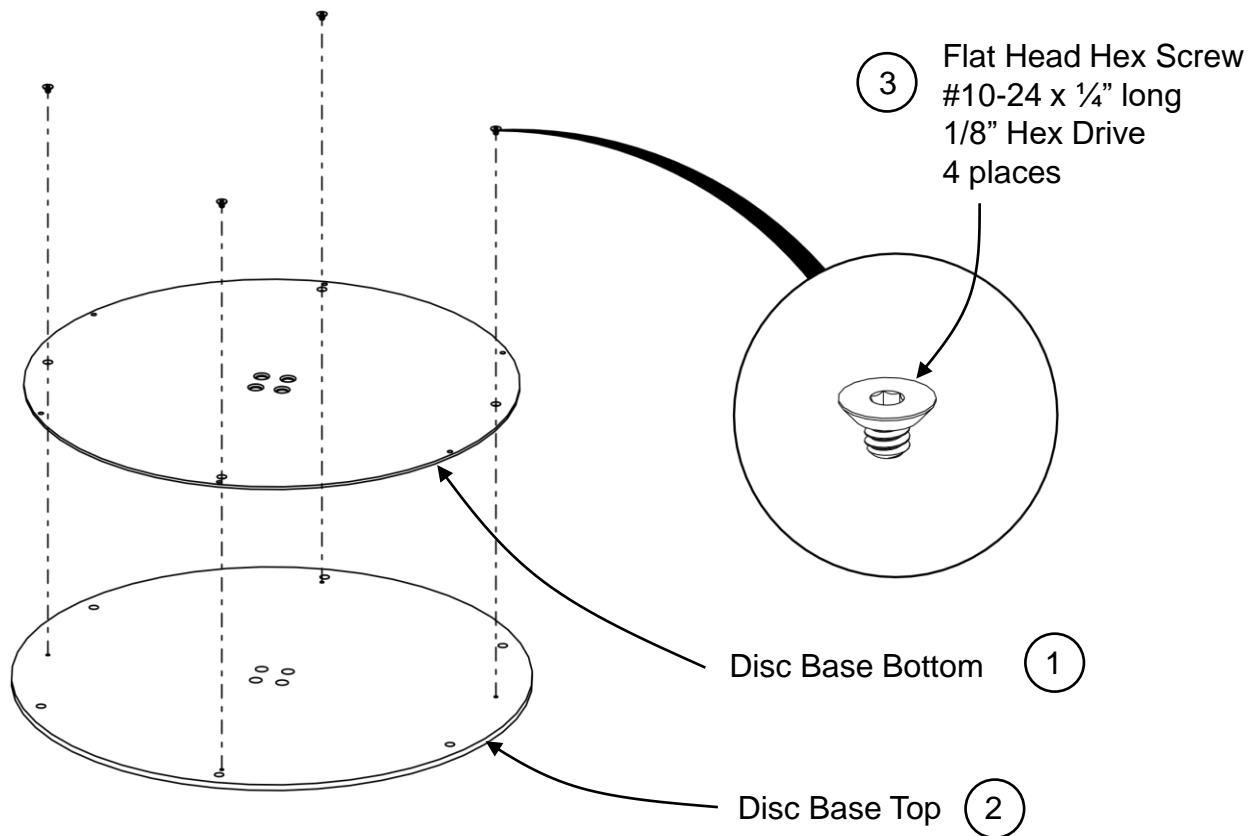

Step 2:

Install (6) glides into the base.

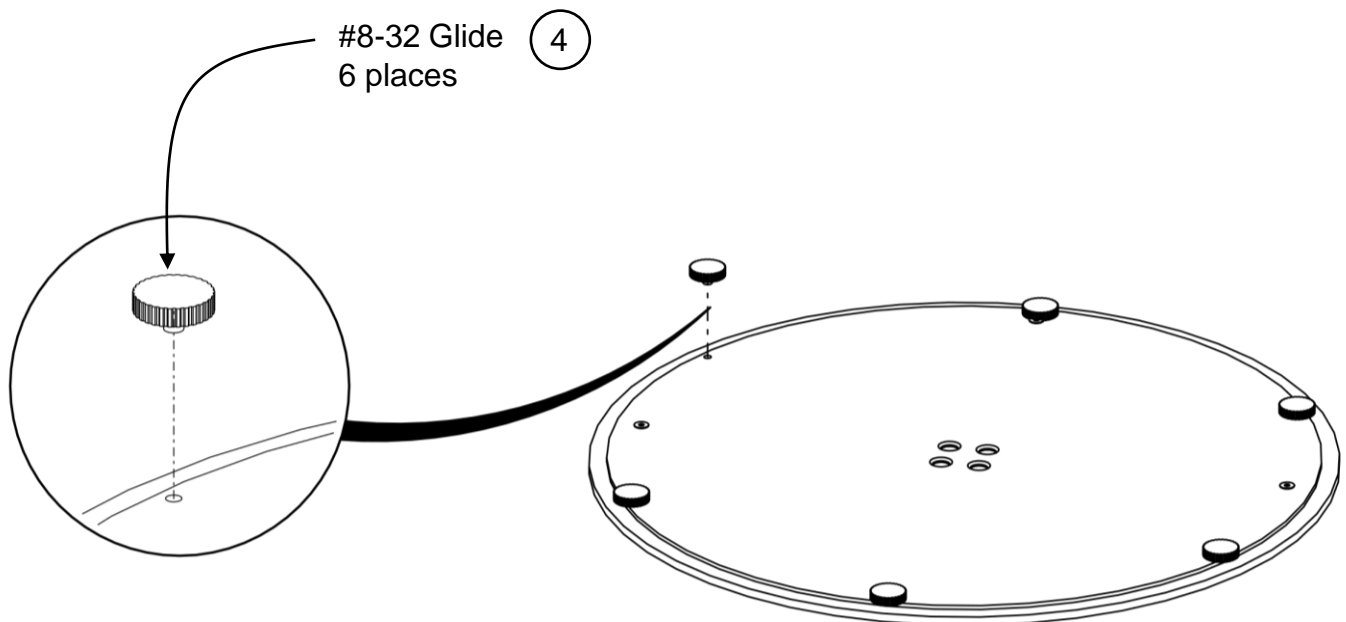

Disc Base Installation Instructions

Step 3:

Connect the disc base to the post leg using (4) #5/16-18 x 1" long flat head screws.

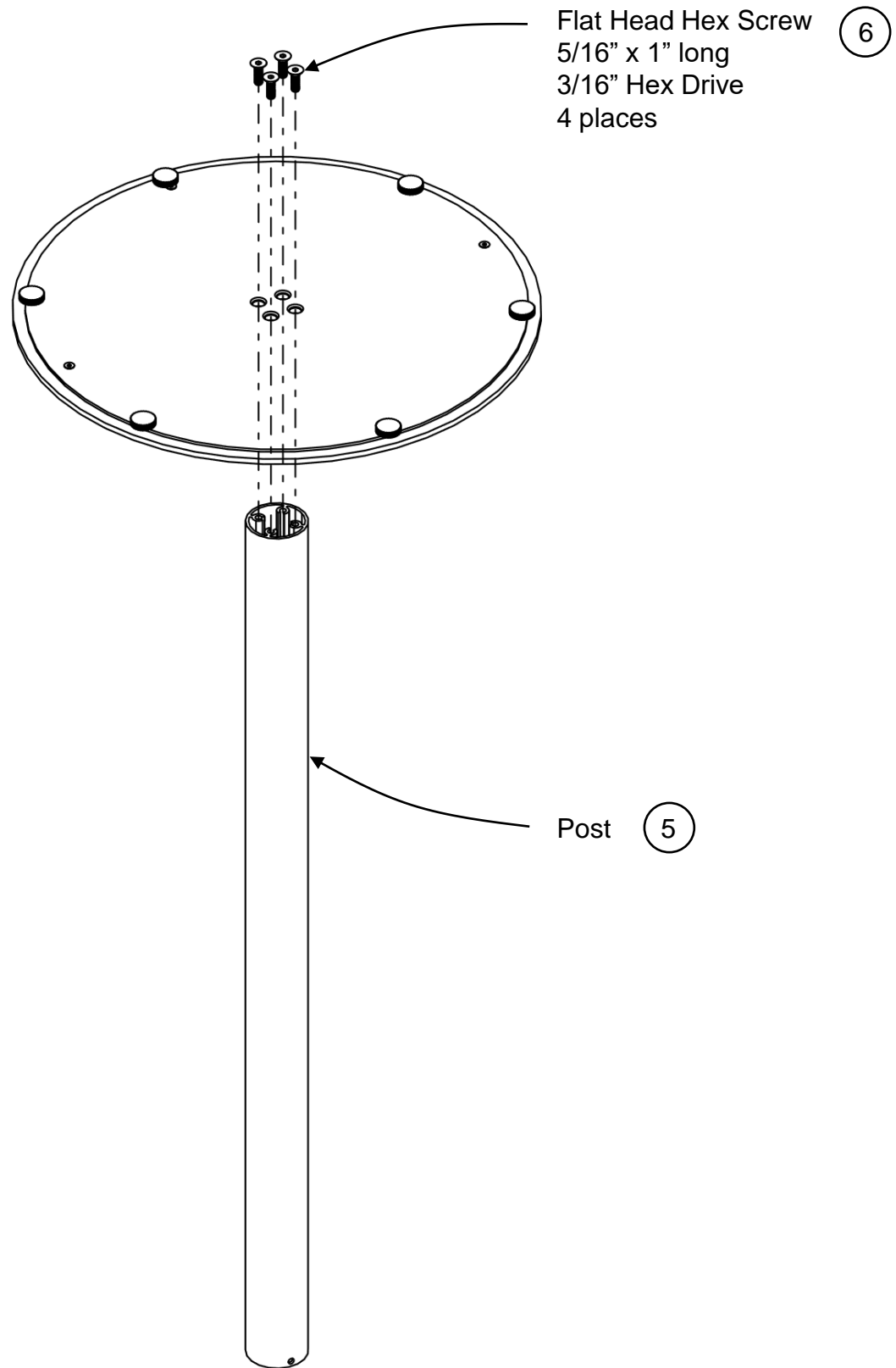

Disc Base Installation Instructions

Step 4:

Connect the top plate to the post leg using (4) #5/16-18 x 1" long flat head screws.

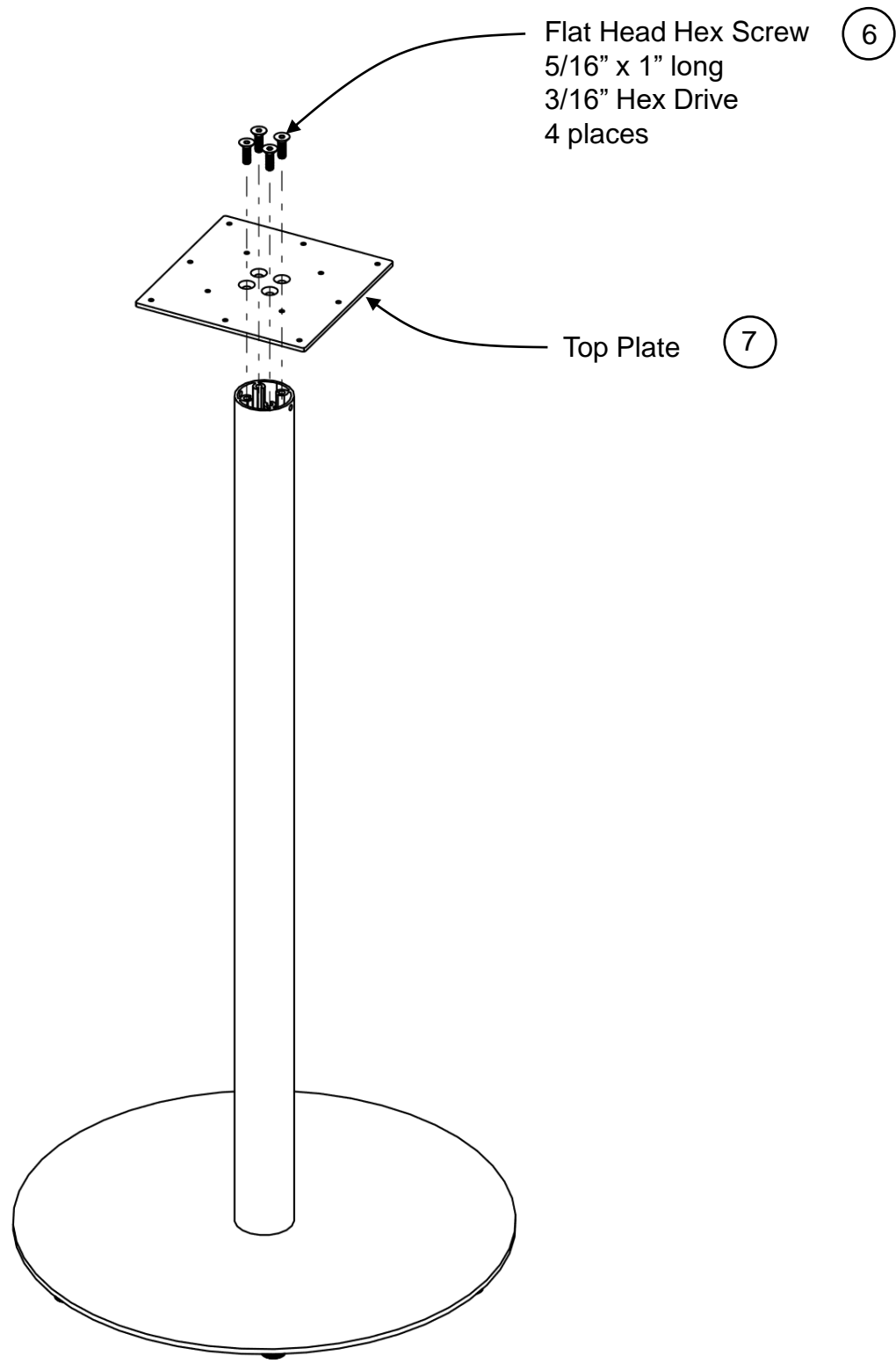

Disc Base Installation Instructions

Step 5:

Attach the worksurface to the top plate using #9 x 7/8" wood screws.

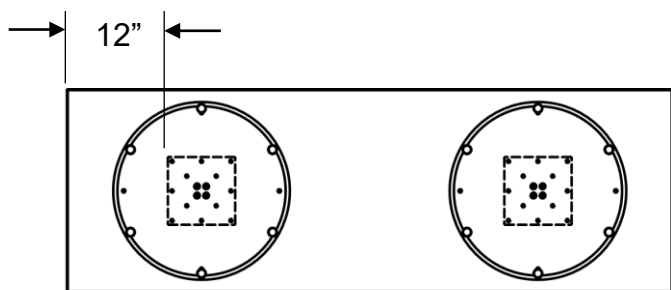
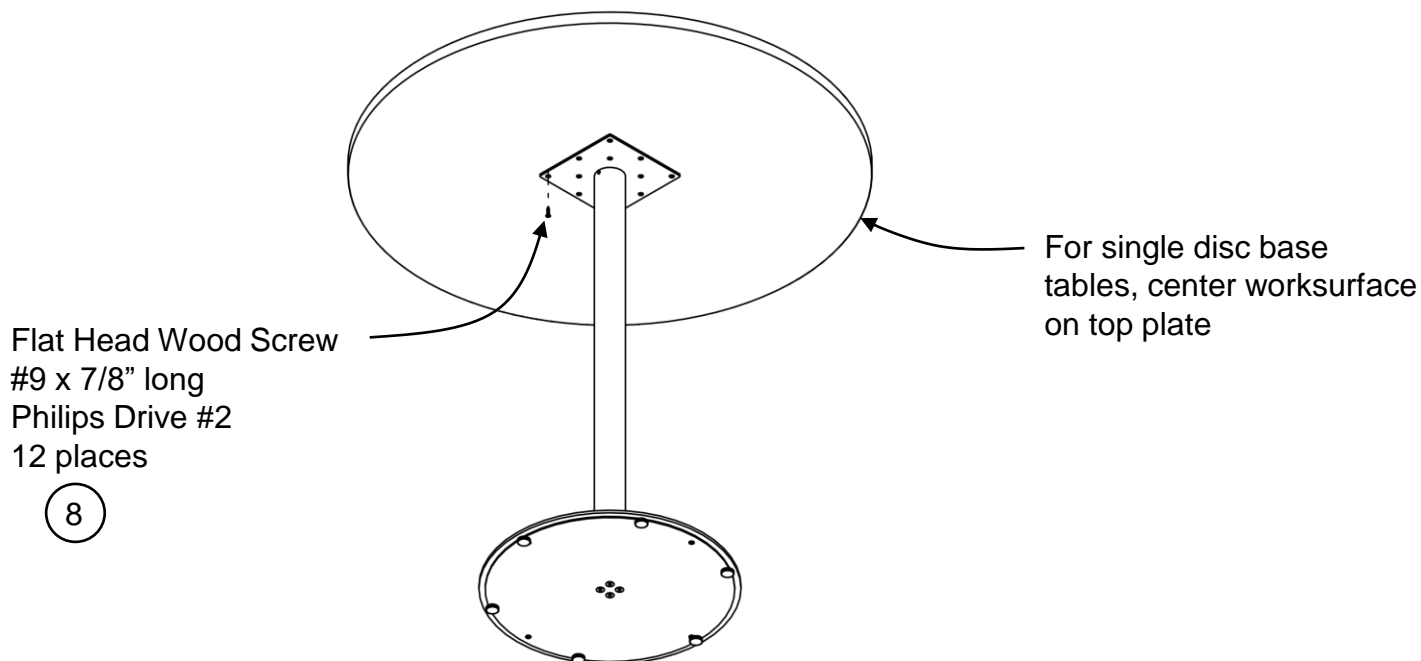

Double Disc Base with
Rectangle Worksurfaces:
Center vertically, 12" from edge

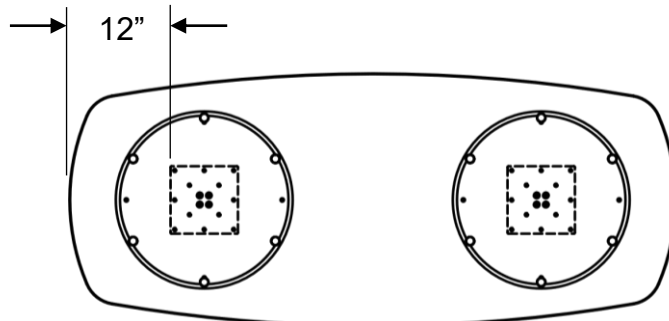

Double Disc Base with
Pebble Worksurfaces:
Center vertically, 12" from edge

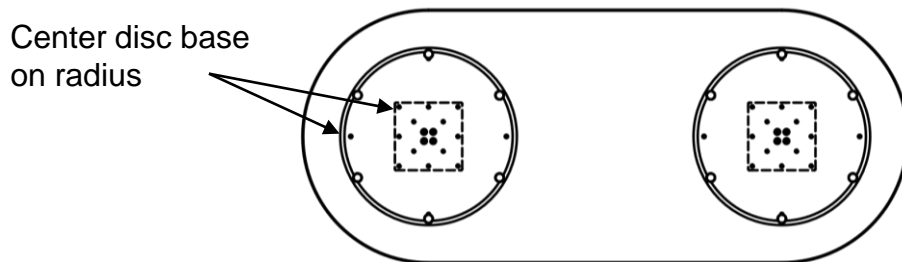

Double Disc Base with
Racetrack Worksurfaces

Disc Base Installation Instructions

Step 6 (for worksurfaces 78w and up only):

Attach the U-channel(s) under the worksurface using #9 x 7/8" wood screws.

