

MARCH 2026 PRICE LIST

Calibrate[®] Countdown

PRODUCT INFORMATION

Calibrate Countdown Statement of Line 3
 Calibrate Countdown Product Details 4
 Calibrate Countdown Finishes 10
 Calibrate Countdown Typicals 11

DESK SHELLS

24" and 30" Deep Desk Shells 21
 Desk Returns and Bridges 22

WORKSURFACES

Rectangular Worksurfaces 23

TABLE DESKS

O-Leg Table Desks, Freestanding O-Legs 24

TABLES

Height Adjustable Tables 25
 Height Adjustable Modesties and Round Tables 26

STORAGE

21" High Floor Bookcases, Laterals 27
 28" High Floor Laterals 28
 21" High BF Pedestal 29
 28" High Floor Pedestals, Laterals 30
 Single Door Towers 31
 Bookcases 32

WALL MOUNTED STORAGE

Wall Mounted Storage 33
 Wall Mounted L Shelves 34
 Wall Mounted Tackboards 35

ACCESSORIES

Standard Series Monitor Arms 36
 Surface Mounted Power, Overhead LED Task Lights 37
 Keyboard Arms, Mouse Trays, Pencil Drawers and Anti-Fatigue Mats 38
 Lock Cores and Keys 39

WARRANTY & TERMS AND CONDITIONS

For Warranty & Terms and Conditions please visit:
<https://www.ais-inc.com>

Calibrate Countdown Statement of Line

CALIBRATE COUNTDOWN

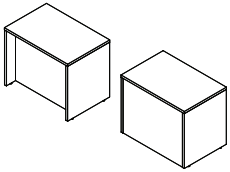

Desk Shells
Full and Recessed Modesty
24 - 30 Deep, 60, 66 or 72 Wide

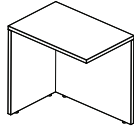

Desk Returns
Left or Right Hand
24 Deep, 42 or 48 Wide
Left Return Shown

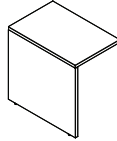

Desk Bridges
24 Deep, 42 or 48 Wide

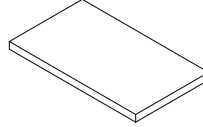

Worksurfaces
24 or 30 Deep, 24 - 72 Wide

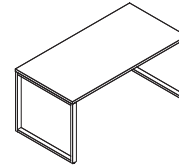

O-Leg Table Desks
29 High, 2mm Edge
24 or 30 Deep
60, 66 and 72 Widths

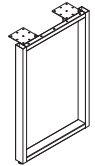

O-Leg
27 High
24, 30 Deep

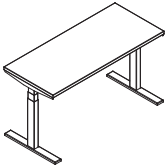

Height Adjustable Tables
Day-to-Day or E-Series
24 or 30 Deep, 42 - 72 Wide

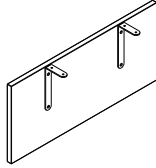

Laminate Modesty
42 - 72 Wide



Day-to-Day Round Table
29 High, 36 Deep

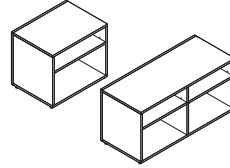

21 High Floor Bookcases
18 or 24 Deep, 24, 30 or 36 Wide

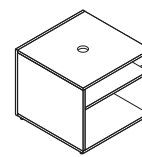

21 High Floor Bookcases for Floating Tops
24 Deep, 24, 30 or 36 Wide

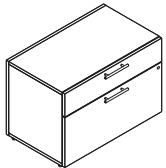

21 High BF Lateral
18 or 24 Deep, 30 or 36 Wide

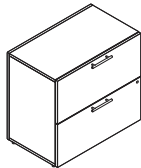

28 High Lateral Files
18 or 24 Deep, 30 or 36 Wide



21 High BF Mobile Pedestal
16 Wide, 18 Deep
on Casters, with Cushion

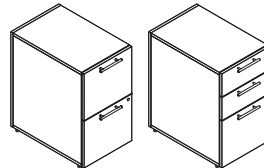

28 High Pedestals
BBF and FF
Full and Partial Depths
24 or 30 Deep



Single Door Towers
66 High, 18 or 24 Deep

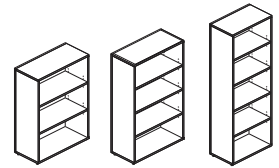

Bookcases
42, 50 and 66 High
14 Deep, 30 and 36 Widths
On Glides

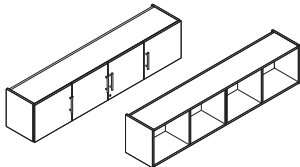

Wall Mounted Overheads
With or Without Hinged Doors
16 High, 36 - 72 Wide

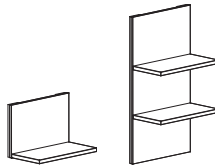

Wall Mounted L Shelves
16, 45 High
36 - 72 Widths, 12 Deep

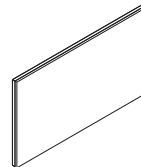

Wall Mounted Tackboards
20 or 28 High, 36 - 72 Wide



Vertical Tackboard Wall Mount
45 High
24, 30 and 36 Widths

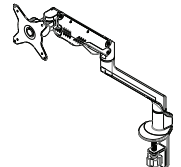

Monitor Arms
Single or Dual

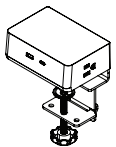

Bella 1050 Clamp

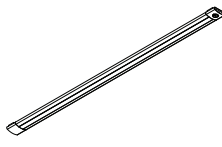

Overhead LED Task Lights

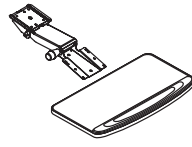

Standard Extended Keyboard Arm

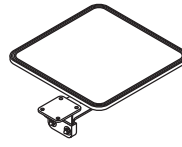

Standard Mouse Tray

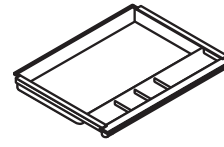

Pencil Drawer

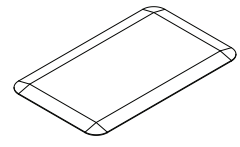

Anti-Fatigue Mat

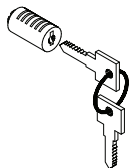

Lock Cores and Keys

Calibrate Countdown Product Details

General Construction Details

- Worksurfaces are 1 1/8" thick, thermally fused laminate with matching edgeband. For available finishes please refer to Finishes section.
- Storage elements have 3/4" thick case construction with 1mm edge.
- Laminate drawer and door faces are 3/4" thick.
- 2mm edges available on worksurfaces. See Product Detail: Edge Profile Details for examples.
- Leveling feet are adjustable up to 1" for all floor supported components.
- Units are finished all over, including the backs.
- Shelves will match body selection
- Laminate patterns such as grain or geometric shapes do not "match" face to face. However this is not noticeable on most laminate options with the exception of natural looking woods where cathedrals appear. AIS cannot guarantee that the woodgrain will match up on the different parts of the same surface.
- AIS recommends the use of mouse pads to protect longevity and integrity of worksurfaces.

Handle Options

- Four handle options are available:
 1. Bar Pull
 2. Loop Pull
 3. Rectangular Pull
 4. L Pull
- All handles are available in Countdown paint selections.
- The bar pull and rectangle pull are available in brushed nickel; the loop pull is available in bright metal. The L Pull is only available with painted options.
- The L Pull is only available with painted options.
- Please see Product Detail: Drawer and Handles Guide for handle examples.
- Symbols default with the Bar Pull but can be adjusted while applying your finishes.

Assembly Details

- Everything ships assembled except for desk shells, returns and bridges. Desk shells are knocked down and height adjustable table desks are partially knocked down.
- Adjustable shelves are adjustable in 32mm increments.
- Easy assembly using CAM and PIN construction allows ease of disassembly.
- Credenzas are modular and units ganged together in the field.
- Supporting hardware for seam connections are included with returns and bridge pieces.

Desk Shells

- Desk shell depths are 24" or 30" deep and widths run from 60" to 72" wide.
- Storage combinations should be specified as partial depth on any desk shell with a modesty (18" deep storage units will also fit under anything with a modesty).
- Desk shells and returns greater than 48" wide will require additional support.
- Leveling feet adjustable up to 1" for Calibrate floor storage.
- Please see Product Detail: Desk Shell Installation for desk shell construction examples.

Returns

- Return shell comes with full height height modesty panel, one full depth end panel and supporting hardware for seam connection.
- Returns can be specified in conjunction with AIS desk shells or specified as a stand alone piece if you have a storage component on the open ended side. Returns can be tied together with a Calibrate surface to storage bracket.
- Please see Product Detail for "L desk" unit examples.

Bridges

- Full modesty flush option only (for bridges without the modesty a standard worksurface can be specified).
- Supporting hardware for seam connections are included.

Calibrate Countdown Product Details

Height Adjustable Table Desks

- Available in 24" and 30" depths and widths run 42" to 72" wide.
- Height adjustable table desks can be specified with or without a modesty.
- Please see Product Detail: Height Adjustable Table Desk Range for information about the height adjustable table desk range.

Suspended Modesty

- Suspended modesties can be specified on the height adjustable table desks.
- Units are 12" high and are offered in 42" to 72" widths. Please follow the details on suspended modesty pricing page for what width modesty goes with what height adjustable table desk.

Storage

- AIS offers a wide variety of storage options and configurations that will work with your office needs. For more details please see below.
- Full depth units come with counterweights except for units with cut-outs.
- Filing offered is side-to-side as standard for pencil lateral and file laterals that are 24" deep as well as partial depth laterals (22" deep and 29" deep).
- Front to back filing is an option that can be purchased as an accessory and will ship separately.
- All storage symbols will show the bar pull, however in worksheet you can swap the handle out as an option to one of the other standard offerings.
- 24" deep pedestals have 20" deep x 12" wide box drawers. Please see Product Detail: Pedestal and Lateral Dimensions for example.
- 30" deep pedestals have 20" deep x 12" wide box drawers. Please see Product Detail: Pedestal and Lateral Dimensions for example.
- Pencil trays are included in the BBF and BF pedestals.

Overheads and Hutches

- Available as wall mounted.
- Tackboards are specified separately, they do not come with the hutches.
- Wall mounted items are secured using cleat mounts. Security screws need to run through the wall cleat to assure that overhead cannot dislodge.

Locks

- Box/Box/Files (BBF) pedestals will only lock the file and the middle box drawer, not the top box.
- File/File (FF) pedestal locks will secure both drawers.
- For all lateral files, wardrobe and storage units the locks will secure the drawers/door for the entire unit.
- Units will come with 2 keys per lock.
- Key-alike options are available per storage unit, additional lock cores may be ordered (for an additional charge) to key-alike an entire office.
- Items with 2 or more locks per unit will be keyed alike.

Lock Guide

Five lock options are offered:

- A - No lock required
- B - Black Lock
- C - Silver Lock
- D - No lock w/ black T-ring for keyed-alike or Digital Lock*
- E - No lock w/ silver T-ring for keyed alike or Digital Lock*

Lock cores and trim rings do not ship installed.

*Keyed alike lock cores must be ordered separately.

Tackboards

- Tackboards are designed to work with your stations need, with or without storage.
- Tackboard fabric direction runs horizontally for 60" to 72" wide pieces.
- Please see Product Detail for examples of tackboard fabric direction.

Calibrate Countdown Product Details

Edge Profile Details

Worksurfaces are 1 1/8" thick, thermally fused laminate with matching edgeband.

2mm Edge Profile Detail

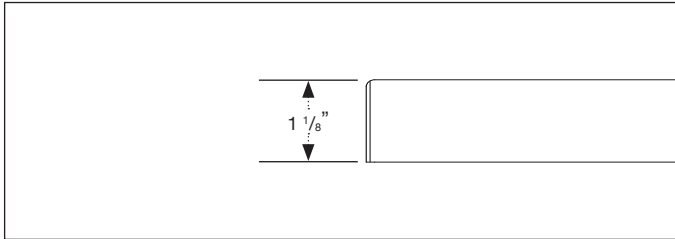

Drawer and Door Handles Guide

Four drawer and door handle options are offered:

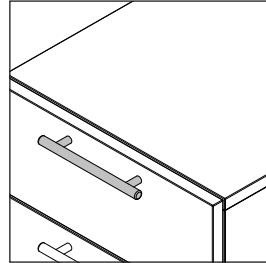

Bar

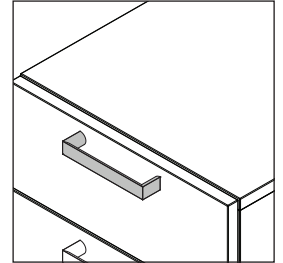

Rectangular

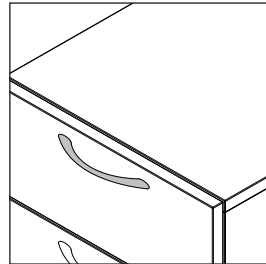

Loop

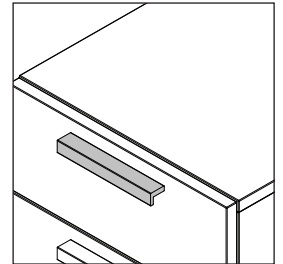

L-Pull

Wood Grain Direction

Grain direction runs vertical for all pieces except for the back of 48" wide cabinets, in which case it runs horizontal. Calibrate wood grain is always vertical on storage fronts and doors. Grains run vertically on items under 60" wide. Items over 60" wide have the grain will run horizontally.

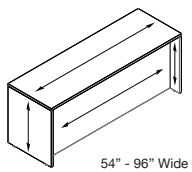

54" - 96" Wide

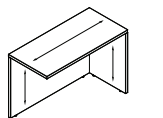

24" - 48" Wide

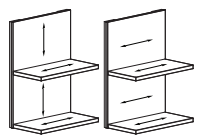
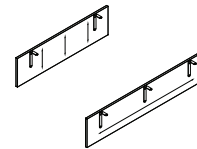
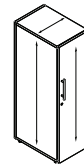
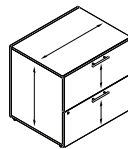
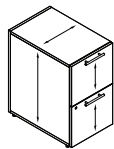

36" - 60" Wide

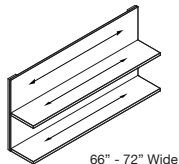

66" - 72" Wide

Calibrate Countdown Product Details

Tackboard Fabric Direction

Tackboard fabrics runs vertically on 24" - 48" width tackboards. Fabric runs horizontally on 54" - 96" width tackboards.

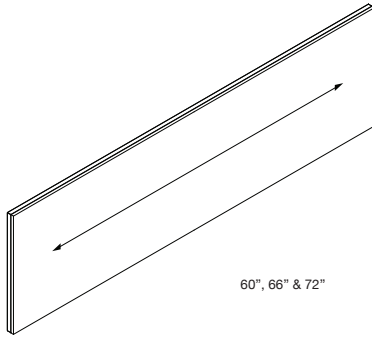

Grommet Locations for Desk Shells, Returns and Bridges

GROMMET OPTIONS			
Option	Location	Desk Shell, Return, Bridges List	Height Adjustable Worksurface List
A	No Grommets	-	-
B	Location 1	+45	+38
C	Location 2	+45	+38
D	Location 3	+45	+38
E	Locations 2 and 3	-	+76
F	Locations 1, 2 and 3	-	+114
G	Locations 1 and 2	-	+76
H	Locations 1 and 3	-	+76

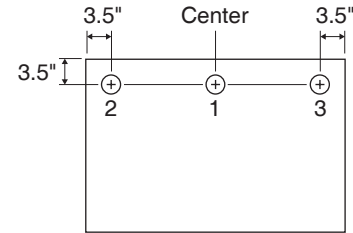

Note: Desk shells with recessed modesties feature grommets that are 8.33" from back edge to allow grommet to be on the inside of modesty.

Left - Right Handing Logic for Calibrate Series

Handing for Cabinet Doors:



Hinge-Left



Hinge-Right

Calibrate Countdown Product Details

Desk Shell Installation

Desk shells, bridges and returns ship flat and must be installed in the field as shown. Storage elements ship fully assembled.

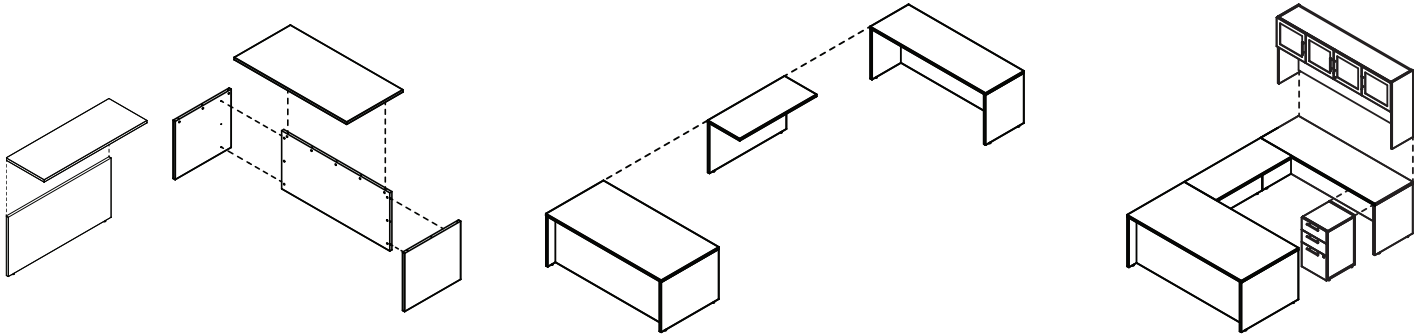

Filing Details

File Bars B, D and E come standard with each drawer box. File Bars B, D and E file side-to-side. File Bars A and C do not come standard and can be purchased for an additional cost. File Bars A and C file front-to-back. From file bar dimensions please see below.

24" Deep Pedestals



16 Wide Letter Front-to-Back
 16 Wide Letter Side-to-Side w/ File Bar A
 16 Wide Legal Side-to-Side w/ File Bar A

18" x 30" Laterals

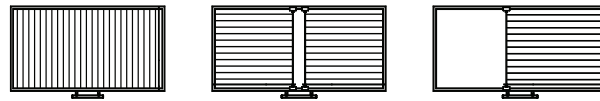

Letter Side-to-Side
 Letter Front-to-Back w/ File Bar A
 Legal Front-to-Back w/ File Bar A

18" x 36" Laterals



Letter Side-to-Side
 Letter Front-to-Back w/ File Bar A (Qty. 2)
 Legal Front-to-Back w/ File Bar A (Qty. 2)
 Letter (Left), Legal (Right) Front-to-Back w/ File Bar A (Qty. 2)

File Bar A: 12" File Bar (#RH-WFB12) File Bar B: 26" File Bar (#RH-WFB26)* File Bar C: 19.5" File Bar (#RH-WFB19) File Bar D: 32" File Bar (#RH-WFB32)* File Bar E: 38" File Bar (#RH-WFB38)*
 *Side-to-side filing bars, come standard with each drawer box.

At AIS, we take great pride in offering a diverse selection of high-quality materials including but not limited to textiles, laminates, PET, mesh, etc. However, AIS cannot guarantee uniformity in dye lots across different production runs. As such, AIS is not liable for any variations in dye lots or color discrepancies in any of our products that may occur between orders. We encourage customers to review samples for color and texture matching prior to purchase. We are committed to providing exceptional products and are confident that our selection of textiles will meet your expectations for both aesthetic appeal and durability.

Calibrate Countdown Product Details

Calibrate Storage Functional Loads

CALIBRATE STORAGE FUNCTIONAL LOADS			
Description	Model Number	Top-to-Bottom Drawer Functional Load (lbs)	Total Functional Load (lbs)
BF Lateral (30" Wide, 18" Deep)	X-PLAT2D3018	15/65	80
BF Lateral (36" Wide, 18" Deep)	X-PLAT2D3618	15/80	95
BBF Pedestal (23" Deep)	X-BBFPFS23	10/10/45	65
BBF Pedestal (24" Deep)	X-BBFPFS24	10/10/45	65
BBF Pedestal (29" Deep)	X-BBFPFS29	10/10/45	65
BBF Pedestal (30" Deep)	X-BBFPFS30	10/10/45	65
FF Pedestal (23" Deep)	X-FFPFS23	45/45	90
FF Pedestal (24" Deep)	X-FFPFS24	45/45	90
FF Pedestal (29" Deep)	X-FFPFS29	45/45	90
FF Pedestal (30" Deep)	X-FFPFS30	45/45	90
Two Drawer Lateral (30" Wide, 18" Deep)	X-LAT2DFS3018	65/65	130
Two Drawer Lateral (36" Wide, 18" Deep)	X-LAT2DFS3618	80/80	160

Calibrate Countdown Finishes

CALIBRATE COUNTDOWN FINISH OPTIONS

Vertical Surface Fabrics	
Name	Grade
Avenue	A
Cape Cod	A
Engage	A
Mirador	A
New England	A
Rainfall	A
Simplicity	A
Twizzle	A

Paint Options		
Name	Color Code	Grade
Black	BK	A
Grey Value 1	GV1	A
Medium Tone	MT	A
Satin White	SW	A

Upholstery Fabric Options*	
Name	Grade
Mirador	A

Mirador comes standard as an antimicrobial upholstery.
 *Available on ped cushions and Volker Cubes only.

Laminate Options	
Name	Grade
Absolute Acajou [†]	A
Landmark	A
Looks Likatre [†]	A
Maritime Dune [†]	A
Neo Walnut	A
True White	A

[†]Indicates a textured laminate.

Edgeband Options		
Name	Color Code	Grade
Absolute Acajou	AA	A
Landmark	LM	A
Looks Likatre	LK	A
Maritime Dune	MD	A
Neo Walnut	NW	A
Satin White / True White	SW/TW	A

Height Adjustable Table Paint Finish Options

Day-to-Day Base Options	
Name	Grade
Black	A
Metallic Silver	A
Satin White	A

E Series Base Options	
Name	Grade
Black	A
Metallic Silver	A
Satin White	A

Typical 1

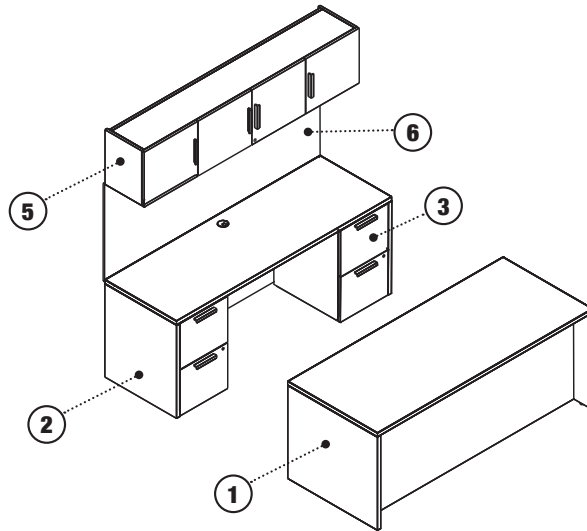

Description	Model Number	Quantity	Notes
1. Desk Shell Full Modesty 29" High x 72" Wide x 30" Deep	X-DS7230	1x	
2. Desk Shell with Full Modesty Flush 29" High x 72" Wide x 24" Deep	X-DSFM7224	1x	
3. Partial Depth FF Pedestal 28" High x 16" Wide x 23" Deep	X-FFPFS23	2x	
4. Partial Depth BBF Pedestal 28" High x 16" Wide x 23" Deep	X-BBFPFS23	1x	
5. Wall Mounted Overhead w/ Cabinet Doors 16" High x 72" Wide x 14" Deep	C-OWMC167214L	1x	
6. Wall Mounted Tackboard 28" High x 72" Wide	X-TACKWM2872	1x	
7. Overhead Task Light 40" Long	A-LEDTL-61540	1x	

Calibrate Countdown Typicals

Typical 2

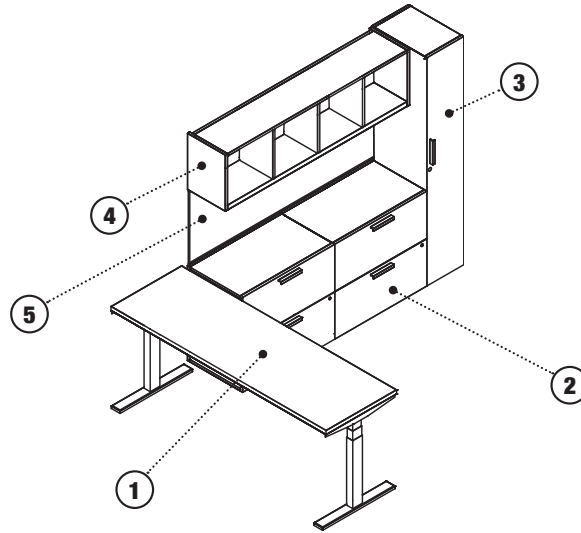

Description	Model Number	Quantity	Notes
1. Day-to-Day 2mm Edge Rectangular Table with Height Adjustable Base 72" Wide x 24" Deep	T-RCR247229HLG2	1x	
2. Full Depth Two Drawer Lateral 28" High x 30" Wide x 18" Deep	X-LAT2DFS3018	2x	
3. Single Door Tower Right Hinge 66" High x 12" Wide x 18" Deep	X-SDCR6618	1x	
4. Wall Mounted Open Overhead 16" High x 60" Wide x 14" Deep	C-OWM166014	1x	
5. Wall Mounted Tackboard 20" High x 60" Wide	X-TACKWM2060	1x	
6. Overhead Task Light 40" Long	A-LEDTL-61540	1x	

Typical 3

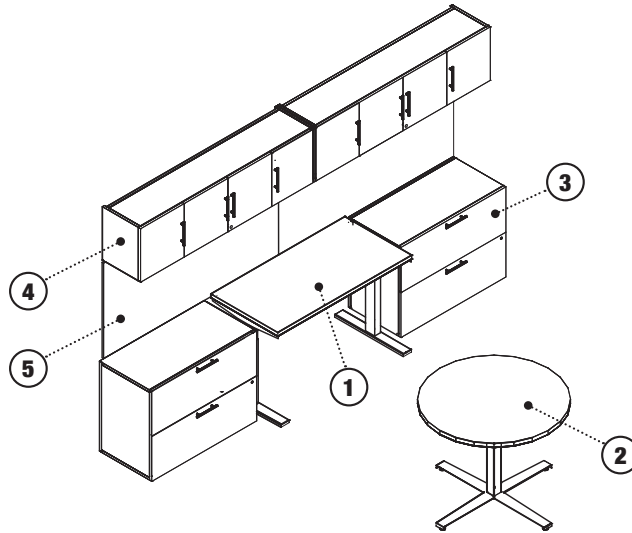

Description	Model Number	Quantity	Notes
1. Day-to-Day 2mm Edge Rectangular Table with Height Adjustable Base 48" Wide x 24" Deep	T-RCR244829HLG2	1x	
2. Day-to-Day 2mm Edge Round Table With Steel X-Base 29" High x 36" Deep	T-RDR3629SXG	1x	
3. Full Depth Two Drawer Lateral 28" High x 36" Wide x 18" Deep	X-LAT2DFS3618	2x	
4. Wall Mounted Overhead w/ Cabinet Doors 16" High x 60" Wide x 14" Deep	C-OWMC166014L	2x	
5. Wall Mounted Tackboard 28" High x 60" Wide	X-TACKWM2860	2x	

Calibrate Countdown Typicals

Typical 4

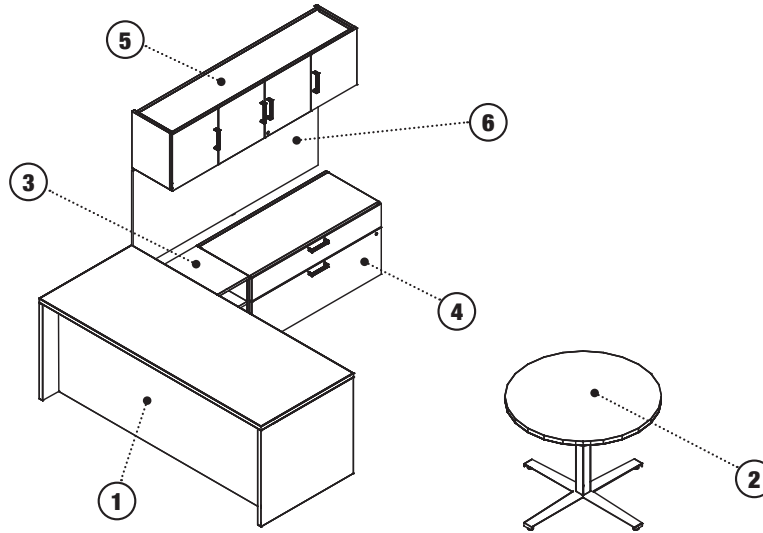

Description	Model Number	Quantity	Notes
1. Desk Shell Full Modesty 29" High x 72" Wide x 30" Deep	X-DS7230	1x	
2. Day-to-Day 2mm Edge Round Table With Steel X-Base 29" High x 36" Deep	T-RDR3629SXG	1x	
3. Floor Bookcase 21" High x 30" Wide x 18" Deep	X-CBC2030	1x	
4. Full Depth BF Lateral 21" High x 36" Wide x 18" Deep	X-PLAT2D3618	1x	
5. Wall Mounted Overhead w/ Cabinet Doors 16" High x 60" Wide x 14" Deep	C-OWMC166014L	1x	
6. Wall Mounted Tackboard 28" High x 60" Wide	X-TACKWM2860	1x	
7. Overhead Task Light 40" Long	A-LEDTL-61540	1x	

Typical 5

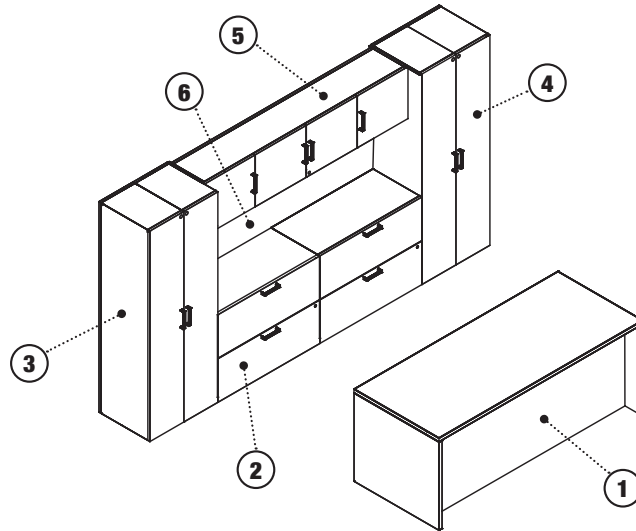

Description	Model Number	Quantity	Notes
1. Desk Shell Full Modesty 29" High x 72" Wide x 30" Deep	X-DS7230	1x	
2. Full Depth Two Drawer Lateral 28" High x 36" Wide x 18" Deep	X-LAT2DFS3618	2x	
3. Single Door Tower Left Hinge 66" High x 12" Wide x 18" Deep	X-SDCL6618	2x	
4. Single Door Tower Right Hinge 66" High x 12" Wide x 18" Deep	X-SDCR6618	2x	
5. Wall Mounted Overhead w/ Cabinet Doors 16" High x 72" Wide x 14" Deep	C-OWMC167214L	1x	
6. Wall Mounted Tackboard 20" High x 72" Wide	X-TACKWM2072	1x	
7. Overhead Task Light 40" Long	A-LEDTL-61540	1x	

Calibrate Countdown Typicals

Typical 6

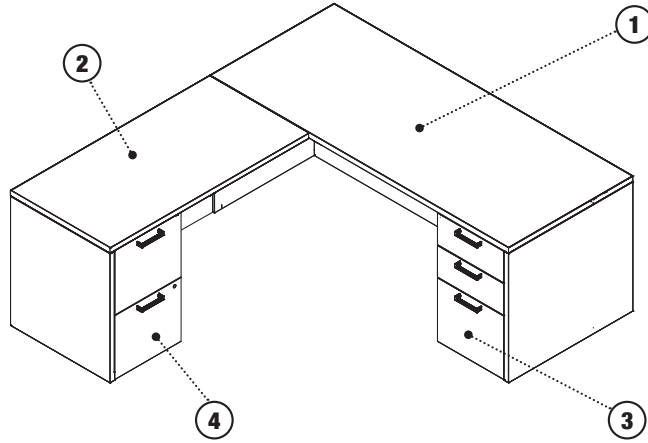

Description	Model Number	Quantity	Notes
1. Desk Shell Full Modesty 29" High x 72" Wide x 30" Deep	X-DS7230	1x	
2. Desk Return Left 29" High x 48" Wide x 24" Deep	X-DR4824L	1x	
3. Partial Depth BBF Pedestal 28" High x 16" Wide x 23" Deep	X-BBFPFS23	1x	
4. Partial Depth FF Pedestal 28" High x 16" Wide x 23" Deep	X-FFPFS23	1x	

Typical 7

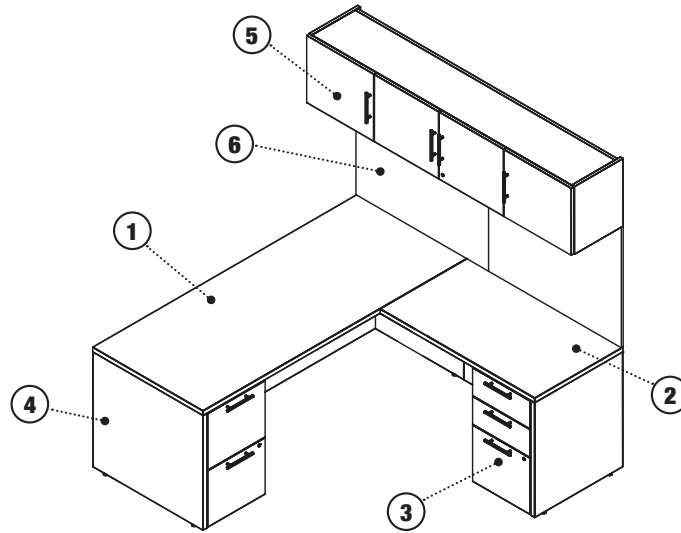

Description	Model Number	Quantity	Notes
1. Desk Shell Full Modesty 29" High x 72" Wide x 30" Deep	X-DS7230	1x	
2. Desk Return Right 29" High x 42" Wide x 24" Deep	X-DR4224R	1x	
3. Partial Depth BBF Pedestal 28" High x 16" Wide x 23" Deep	X-BBFPFS23	1x	
4. Full Depth FF Pedestal 28" High x 16" Wide x 24" Deep	X-FFPFS24	1x	
5. Wall Mounted Overhead w/ Cabinet Doors 16" High x 72" Wide x 14" Deep	C-OWMC167214L	1x	
6. Wall Mounted Tackboard 28" High x 72" Wide	X-TACKWM2872	1x	
7. Overhead Task Light 40" Long	A-LEDTL-61540	1x	

Calibrate Countdown Typicals

Typical 8

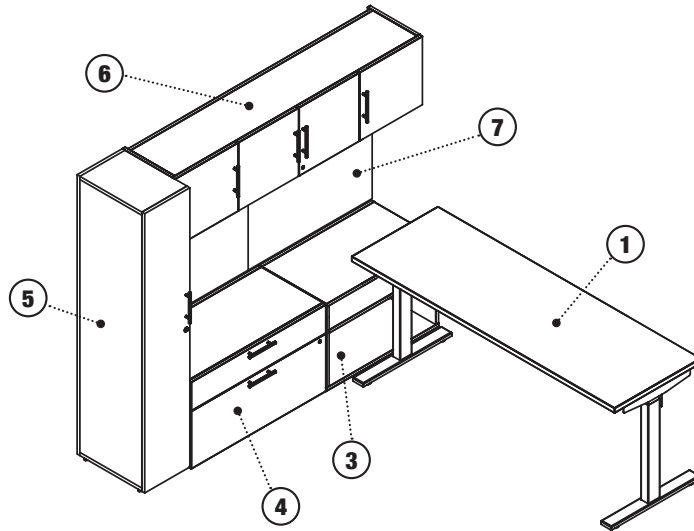

Description	Model Number	Quantity	Notes
1. E-Series 2mm Edge Rectangular Table with Height Adjustable Base 72" Wide x 30" Deep	T-RCR307229HG	1x	
2. Suspended Height Adjustable Modesty 12" High x 72" Wide	X-HATM1272	1x	
3. Floor Bookcase 21" High x 30" Wide x 18" Deep	X-CBC2030	1x	
4. Full Depth BF Lateral 21" High x 36" Wide x 18" Deep	X-PLAT2D3618	1x	
5. Single Door Tower Left Hinge 66" High x 12" Wide x 18" Deep	X-SDCL6618	1x	
6. Wall Mounted Overhead w/ Cabinet Doors 16" High x 66" Wide x 14" Deep	C-OWMC166614L	1x	
7. Wall Mounted Tackboard 28" High x 66" Wide	X-TACKWM2866	1x	
8. Overhead Task Light 40" Long	A-LEDTL-61540	1x	

Typical 9

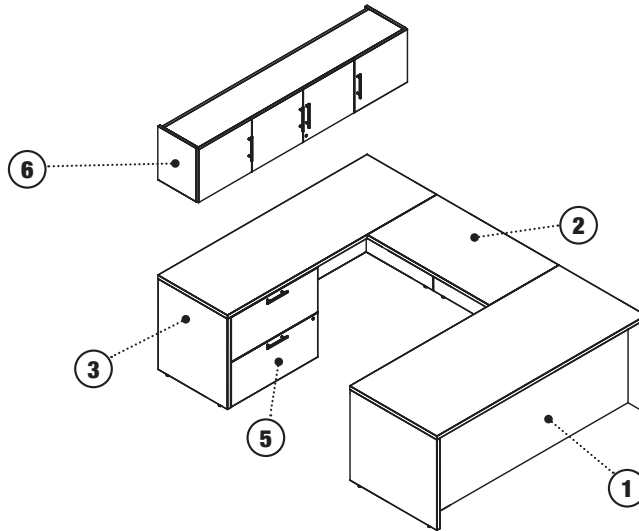

Description	Model Number	Quantity	Notes
1. Desk Shell Full Modesty 29" High x 72" Wide x 30" Deep	X-DS7230	1x	
2. Desk Bridge with Full Modesty Flush 29" High x 42" Wide x 24" Deep	X-DB4224	1x	
3. Desk Shell with Full Modesty Flush 29" High x 72" Wide x 24" Deep	X-DSFM7224	1x	
4. Full Depth BBF Pedestal 28" High x 16" Wide x 24" Deep	X-BBFPFS24	1x	
5. Full Depth Two Drawer Lateral 28" High x 30" Wide x 18" Deep	X-LAT2DFS3018	1x	
6. Wall Mounted Overhead w/ Cabinet Doors 16" High x 72" Wide x 14" Deep	C-OWMC167214L	1x	
7. Wall Mounted Tackboard 28" High x 72" Wide	X-TACKWM2872	1x	
8. Overhead Task Light 40" Long	A-LEDTL-61540	1x	

Calibrate Countdown Typicals

Typical 10

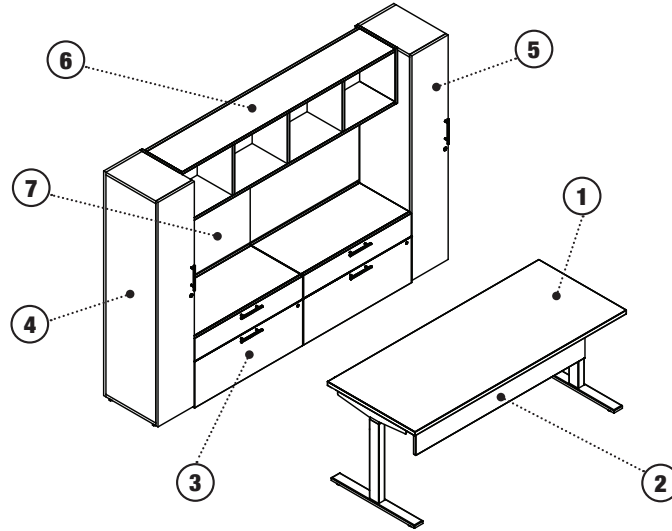

Description	Model Number	Quantity	Notes
1. Day-to-Day 2mm Edge Rectangular Table with Height Adjustable Base 72" Wide x 30" Deep	T-RCR307229HLG2	1x	
2. Suspended Height Adjustable Modesty 12" High x 72" Wide	X-HATM1272	1x	
3. Full Depth BF Lateral 21" High x 36" Wide x 18" Deep	X-PLAT2D3618	2x	
4. Single Door Tower Left Hinge 66" High x 12" Wide x 18" Deep	X-SDCL6618	1x	
5. Single Door Tower Right Hinge 66" High x 12" Wide x 18" Deep	X-SDCR6618	1x	
6. Wall Mounted Open Overhead 16" High x 72" Wide x 14" Deep	C-OWM167214	1x	
7. Wall Mounted Tackboard 28" High x 72" Wide	X-TACKWM2872	1x	
8. Overhead Task Light 40" Long	A-LEDTL-61540	1x	

24" and 30" Deep Desk Shells

24" DEEP DESK SHELL FULL MODESTY

H	W	D	Model Number	List
29	60	24	X-DS6024	1,574
29	66	24	X-DS6624	1,630
29	72	24	X-DS7224	1,688

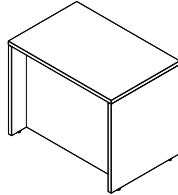

30" DEEP DESK SHELL FULL MODESTY

H	W	D	Model Number	List
29	60	30	X-DS6030	1,609
29	66	30	X-DS6630	1,763
29	72	30	X-DS7230	1,824

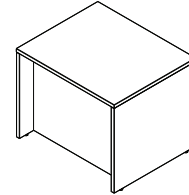

Specify

Notes

- Laminate Selection for Worksurface
- Laminate Selection for Base
- Grommet Location

24" DEEP DESK SHELL WITH FULL MODESTY FLUSH

H	W	D	Model Number	List
29	60	24	X-DSFM6024	1,576
29	66	24	X-DSFM6624	1,631
29	72	24	X-DSFM7224	1,689

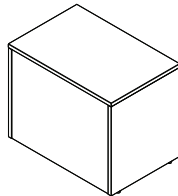

30" DEEP DESK SHELL WITH FULL MODESTY FLUSH

H	W	D	Model Number	List
29	60	30	X-DSFM6030	1,697
29	66	30	X-DSFM6630	1,763
29	72	30	X-DSFM7230	1,824

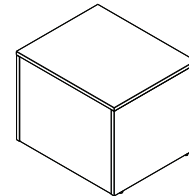

Specify

Notes

- Laminate Selection Worksurface
- Laminate Selection for Base
- Grommet Location
- Unsupported worksurfaces greater than 48" wide will require additional support.

Desk Returns and Bridges

DESK RETURNS					
H	W	D	Left	Right	List
			Model Number	Model Number	
29	42	24	X-DR4224L	X-DR4224R	1,233
29	48	24	X-DR4824L	X-DR4824R	1,286

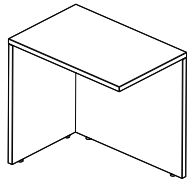

Left

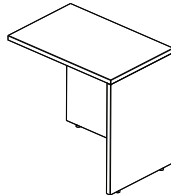

Right

Specify	Notes
<ul style="list-style-type: none"> • Laminate Selection for Worksurface • Laminate Selection for Base • Grommet Location 	<ul style="list-style-type: none"> • Unsupported worksurfaces greater than 48" wide will require additional support.

DESK BRIDGE WITH FULL MODESTY FLUSH					
H	W	D	Model Number	List	
29	42	24	X-DB4224	921	
29	48	24	X-DB4824	960	

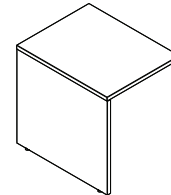

Specify	Notes
<ul style="list-style-type: none"> • Laminate Selection for Worksurface • Laminate Selection for Base • Grommet Location 	

Rectangular Worksurfaces

24" DEEP RECTANGULAR WORKSURFACES

D	W	Model Number	List
24	24	W-WS2424	424
24	30	W-WS2430	506
24	36	W-WS2436	551
24	42	W-WS2442	598
24	48	W-WS2448	649
24	54	W-WS2454	721
24	60	W-WS2460	796
24	66	W-WS2466	904
24	72	W-WS2472	989

30" DEEP RECTANGULAR WORKSURFACES

D	W	Model Number	List
30	24	W-WS3024	506
30	30	W-WS3030	595
30	36	W-WS3036	648
30	42	W-WS3042	768
30	48	W-WS3048	831
30	54	W-WS3054	964
30	60	W-WS3060	964
30	66	W-WS3066	1,087
30	72	W-WS3072	1,182

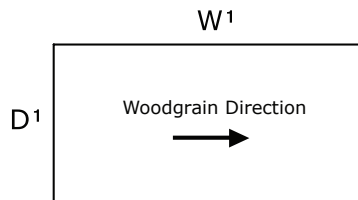

Specify	Notes
<ul style="list-style-type: none"> • Laminate Selection • Color Selection for 2mm Edge • Additional Grommet Locations (+38) • Grommet Cover Color (if applicable) 	<ul style="list-style-type: none"> • Worksurface support hardware is specified separately. • Grommet holes with covers are specified as options. • It is highly recommended that a center support be used on all worksurfaces greater than 48" width. When spanning panel connections with a worksurface greater than 48" wide, an additional center cantilever is recommended for added support. Otherwise, a U-channel is recommended for additional center worksurface support. • It is not recommended that 36", 42" and 48" deep worksurfaces be cantilevered to panels. Instead worksurfaces with those depths must be panel hung. • It is highly recommended that an additional front support, such as a combination leg or full laminate support panel, also be specified.

O-Leg Table Desks, Freestanding O-Legs

2MM EDGE O-LEG TABLE DESKS

D	W	H	Model Number	List
24	60	29	T-RCR246029OLG	3,398
24	66	29	T-RCR246629OLG	3,471
24	72	29	T-RCR247229OLG	3,526
30	60	29	T-RCR306029OLG	3,675
30	66	29	T-RCR306629OLG	3,761
30	72	29	T-RCR307229OLG	3,827

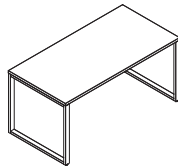

Specify

- Laminate Selection for Worksurface
- Color Selection for Edge
- Color Selection for Leg

Notes

- Steel O-Legs have a 1" x 2" profile.
- O-Legs have 1 1/2" leveling glides.
- Ships unassembled.
- Includes U channel(s) to reinforce the work surface.
- Field installed grommets are required to be inset for O-Leg attachment bracket.

FREESTANDING O-LEGS

H	D	Model Number	List
27	24	WFS-OLW2724FS-2	1,169
27	30	WFS-OLW2730FS-2	1,299

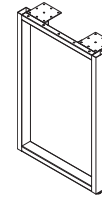

Specify

- Paint Selection

Notes

- May be used as shared leg in applications up to 72" wide.
- O-Leg for use with run off and freestanding table applications.
- Steel O-Legs have a 1" x 2" profile.
- O-Legs have 1 1/2" leveling glides.
- Not sized for use with knife edge work surfaces.
- Not for panel mounting, for panel mounting leg see panel specific price list.
- Use in conjunction with an appropriate sized U channel(s) when supporting a span of 48" or greater.
- AIS standard corner grommet locations will be obscured by this leg. Consult specials team for any grommet location near O-legs.

Height Adjustable Tables

DAY-TO-DAY 2MM EDGE RECTANGULAR TABLES WITH HEIGHT ADJUSTABLE BASES

D	W	H	Worksurface	Model Number	List
24	42	29	23 x 40	T-RCR244229HLG2	3,303
24	48	29	23 x 46	T-RCR244829HLG2	3,466
24	54	29	23 x 52	T-RCR245429HLG2	3,527
24	60	29	23 x 58	T-RCR246029HLG2	3,548
24	66	29	23 x 64	T-RCR246629HLG2	3,570
24	72	29	23 x 70	T-RCR247229HLG2	3,593
30	42	29	29 x 40	T-RCR304229HLG2	3,334
30	48	29	29 x 46	T-RCR304829HLG2	3,548
30	54	29	29 x 52	T-RCR305429HLG2	3,575
30	60	29	29 x 58	T-RCR306029HLG2	3,603
30	66	29	29 x 64	T-RCR306629HLG2	3,629
30	72	29	29 x 70	T-RCR307229HLG2	3,657

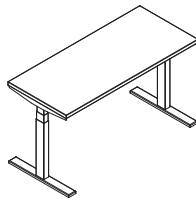

Specify

- Laminate Selection for Worksurface
- Color Selection for Edge
- Color Selection for Base
- Additional Grommet Locations (+38)
- Grommet Cover Color (if applicable)

Notes

- Features a 3-stage table base.
- Dimensions shown for Height Adjustable Tables are the nominal sizes. Actual sizes will be smaller to provide a 1" perimeter gap required for safety.
- Height adjustable tables available on glides only.
- Grommet holes with covers are specified as options.
- Bases available in black, satin white, or metallic silver.
- For base only please see Support price list.

E SERIES 2MM EDGE RECTANGULAR TABLES WITH HEIGHT ADJUSTABLE BASES

D	W	H	Worksurface	Model Number	List
24	42	29	23 x 40	T-RCR244229HG	3,023
24	48	29	23 x 46	T-RCR244829HG	3,186
24	54	29	23 x 52	T-RCR245429HG	3,246
24	60	29	23 x 58	T-RCR246029HG	3,266
24	66	29	23 x 64	T-RCR246629HG	3,289
24	72	29	23 x 70	T-RCR247229HG	3,312
30	42	29	29 x 40	T-RCR304229HG	3,054
30	48	29	29 x 46	T-RCR304829HG	3,266
30	54	29	29 x 52	T-RCR305429HG	3,294
30	60	29	29 x 58	T-RCR306029HG	3,321
30	66	29	29 x 64	T-RCR306629HG	3,351
30	72	29	29 x 70	T-RCR307229HG	3,377

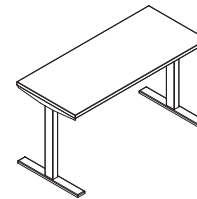

Specify

- Laminate Selection for Worksurface
- Color Selection for Edge
- Color Selection for Base
- Additional Grommet Locations (+38)
- Grommet Cover Color (if applicable)

Notes

- Features a 2-stage table base.
- Dimensions shown for Height Adjustable Tables are the nominal sizes. Actual sizes will be smaller to provide a 1" perimeter gap required for safety.
- Height adjustable tables available on glides only.
- Grommet holes with covers are specified as options.
- Bases available in black, satin white, or metallic silver.

Height Adjustable Modesties and Round Tables

SUSPENDED HEIGHT ADJUSTABLE MODESTY

H	Nominal Width	Actual Width	Model Number	List
12	42	26	X-HATM1242	883
12	48	32	X-HATM1248	897
12	54	38	X-HATM1254	910
12	60	44	X-HATM1260	921
12	66	50	X-HATM1266	934
12	72	56	X-HATM1272	946

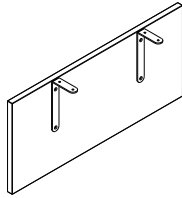

Specify

- Laminate Selection

Notes

This optional modesty panel can be specified on the height adjustable table desk.

DAY-TO-DAY 2MM EDGE ROUND TABLES WITH STEEL X-BASES

D	H	Model Number	List
36	29	T-RDR3629SXG	1,591



Specify

- Laminate Selection for Worksurface
- Color Selection for Edge
- Color Selection for Base

Notes

21" High Floor Bookcases, Laterals

FLOOR BOOKCASES

H	W	D	Model Number	List
21	24	18	X-CBC2024	1,676
21	30	18	X-CBC2030	1,757
21	36	18	X-CBC2036	2,059
21	24	24	X-CBC202424	1,676
21	30	24	X-CBC203024	1,737
21	36	24	X-CBC203624	2,057

FLOOR BOOKCASES FOR FLOATING TOPS

H	W	D	Model Number	List
21	24	24	X-BCRO2424	2,078
21	30	24	X-BCRO2430	2,165
21	36	24	X-BCRO2436	2,253

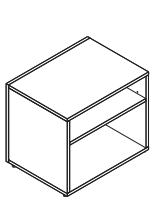

24" - 30" Wide

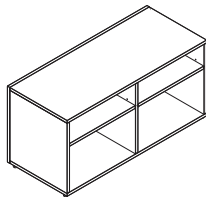

36" Wide

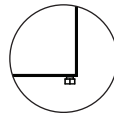

No feet.
3/8" tall glides.

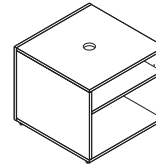

24", 30", 36" Wide

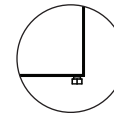

No feet.
3/8" tall glides.

Specify

Notes

• Laminate Selection for Unit

• Adjustable shelves have 6" of adjustability.

BF LATERALS

H	W	D	Depth	Counterweight	Model Number	List
21	30	18	Full	Y	X-PLAT2D3018	3,085
21	36	18	Full	Y	X-PLAT2D3618	3,258
21	30	24	Full	Y	X-PLAT2D3024	3,319
21	36	24	Full	Y	X-PLAT2D3624	3,511

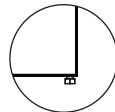
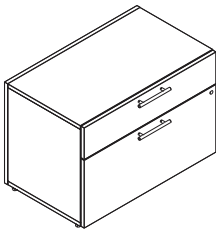

No feet.
3/8" tall glides.

Specify

Notes

• Laminate Selection for Case

• Laminate Selection for Face/Drawer

• Handle Selection

• Handle Paint Selection

• Lock Selection

• For functional loads see Calibrate Product Details.

• Lock cores and trim rings ship separately.

• One core removal key will be included for every 25 units on an order (1-25 units receive 1 core key; 25-50 units receive 2 core keys, etc.). Additional core removal keys can be purchased separately; refer to the Accessories section.

28" High Floor Laterals

TWO DRAWER LATERALS

H	W	D	Depth	Counterweight	Model Number	List
28	30	18	Full	Y	X-LAT2DFS3018	3,330
28	36	18	Full	Y	X-LAT2DFS3618	3,531
28	30	24	Full	Y	X-LAT2DFS3024	3,618
28	36	24	Full	Y	X-LAT2DFS3624	3,844

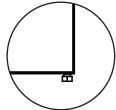
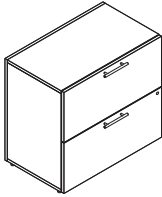

No feet.
3/8" tall glides.

Specify	Notes
<ul style="list-style-type: none"> • Laminate Selection for Case • Laminate Selection for Face/Drawer • Handle Selection • Handle Paint Selection • Lock Selection 	<ul style="list-style-type: none"> • See Product Details for more information on how to specify Full and Partial depth. For functional loads see Calibrate Product Details. • Partial Depth required when modesty is applied. • Lock cores and trim rings ship separately. • One core removal key will be included for every 25 units on an order (1-25 units receive 1 core key; 25-50 units receive 2 core keys, etc.). Additional core removal keys can be purchased separately; refer to the Accessories section.

BF PEDESTAL ON CASTERS

H	W	D	Model Number	List
21	16	18	C-BFP18M	2,804



16" Wide
(With Cushion)

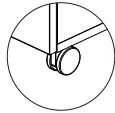

Product is elevated
on 2 5/8" casters.

Specify	Notes
<ul style="list-style-type: none"> • Laminate Selection for Case • Fabric Selection for Cushion • Laminate Selection for Face/Drawer • Handle Selection • Handle Paint Selection • Lock Selection 	<ul style="list-style-type: none"> • Height shown without cushions. 21" high pedestals on casters have an actual height of 24 1/8" with a cushion. • For functional loads see Universal Storage Product Details. • Mobile pedestals come with two locking and two non-locking casters. • Lock cores and trim rings ship separately. • One core removal key will be included for every 25 units on an order (1-25 units receive 1 core key; 25-50 units receive 2 core keys, etc.). Additional core removal keys can be purchased separately; refer to the Accessories section.

28" High Floor Pedestals, Laterals

BBF PEDESTALS

H	W	D	Depth	Counterweight	Model Number	List
28	16	23	Partial	N	X-BBPFPS23	2,204
28	16	24	Full	Y	X-BBPFPS24	2,220
28	16	29	Partial	N	X-BBPFPS29	2,260
28	16	30	Full	Y	X-BBPFPS30	2,290

FF PEDESTALS

H	W	D	Depth	Counterweight	Model Number	List
28	16	23	Partial	N	X-FFPFS23	2,137
28	16	24	Full	Y	X-FFPFS24	2,163
28	16	29	Partial	N	X-FFPFS29	2,199
28	16	30	Full	Y	X-FFPFS30	2,214

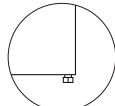
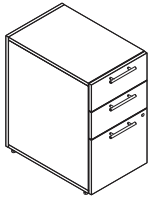

No feet.
3/8" tall glides.

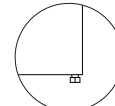
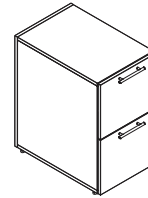

No feet.
3/8" tall glides.

Specify

- Laminate Selection for Case
- Laminate Selection for Face/Drawer
- Handle Selection
- Handle Paint Selection
- Lock Selection

Notes

- See Product Details for more information on how to specify Full and Partial depth. For functional loads see Calibrate Product Details.
- Partial Depth required when modesty is applied.
- Lock cores and trim rings ship separately.
- One core removal key will be included for every 25 units on an order (1-25 units receive 1 core key; 25-50 units receive 2 core keys, etc.). Additional core removal keys can be purchased separately; refer to the Accessories section.

SINGLE DOOR TOWERS					
H	W	D	Left-Hinge	Right-Hinge	List
			Model Number	Model Number	
66	12	18	X-SDCL6618	X-SDCR6618	2,945
66	12	24	X-SDCL6624	X-SDCR6624	3,101

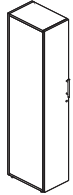

66" High
(Left-Hinge)

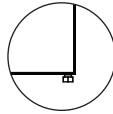

No feet.
3/8" tall glides.

Specify	Notes
<ul style="list-style-type: none"> • Laminate Selection for Case • Laminate Selection for Door/Face • Handle Selection • Handle Paint Selection • Lock Selection 	<ul style="list-style-type: none"> • Left-hinge towers shown. • Towers must be ganged together with another unit or secured to a wall. • Towers are wardrobe style and do not have shelving. • 18" deep units come equipped with a coat hook. 24" deep units come equipped with a coat rod. • Single door tower handles are designed to be aligned with adjacent storage elements in private office settings. • Lock cores and trim rings ship separately. • One core removal key will be included for every 25 units on an order (1-25 units receive 1 core key; 25-50 units receive 2 core keys, etc.). Additional core removal keys can be purchased separately; refer to the Accessories section. • 12"W storage must be secured to a wall or panel, or connected to another unit for stability. A panel support bracket can be found in Accessories.

Bookcases

BOOKCASES					
H	W	D	Model Number	List	
42	30	14	X-BC423015	2,078	
42	36	14	X-BC423615	2,170	
50	30	14	X-BC503015	2,161	
50	36	14	X-BC503615	2,258	
66	30	14	X-BC663015	2,384	
66	36	14	X-BC663615	2,513	

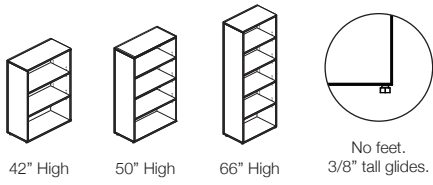

Specify **Notes**

• Laminate Selection for Unit

Wall Mounted Storage

WALL MOUNTED OPEN OVERHEAD

H	W	D	Model Number	List
16	36	14	C-OWM163614	1,713
16	42	14	C-OWM164214	1,756
16	48	14	C-OWM164814	1,808
16	54	14	C-OWM165414	2,067
16	60	14	C-OWM166014	2,110
16	66	14	C-OWM166614	2,162
16	72	14	C-OWM167214	2,204

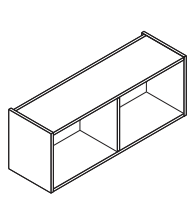

36" - 48" Wide

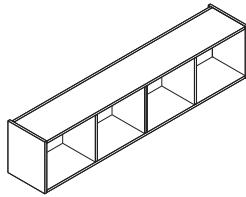

54" - 72" Wide

Specify

- Laminate Selection for Unit

Notes

- Wall mounted laminate storage ships with a minimum of two MDF cleats depending on size. One cleat ships attached to the unit, and one cleat ships separately.
- Cleats are unfinished and visible from the top view. Please note: depending on application, a top may be required through specials.

WALL MOUNTED OVERHEAD WITH CABINET DOORS

H	W	D	Model Number	List
16	36	14	C-OWMC163614L	2,283
16	42	14	C-OWMC164214L	2,329
16	48	14	C-OWMC164814L	2,385
16	54	14	C-OWMC165414L	2,843
16	60	14	C-OWMC166014L	2,891
16	66	14	C-OWMC166614L	2,952
16	72	14	C-OWMC167214L	3,000

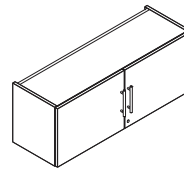

36" - 48" Wide

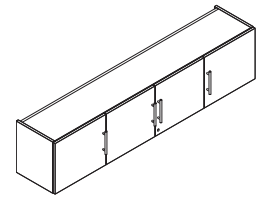

54" - 72" Wide

Specify

- Laminate Selection for Case
- Laminate Selection for Door/Face
- Handle Selection
- Handle Paint Selection
- Lock Selection

Notes

- Lock cores and trim rings ship separately.
- One core removal key will be included for every 25 units on an order (1-25 units receive 1 core key; 25-50 units receive 2 core keys, etc.). Additional core removal keys can be purchased separately; refer to the Accessories section.
- Wall mounted laminate storage ships with a minimum of two MDF cleats depending on size. One cleat ships attached to the unit, and one cleat ships separately
- Cleats are unfinished and visible from the top view. Please note: depending on application, a top may be required through specials.

Wall Mounted L Shelves

WALL MOUNTED L SHELVES						
H	W	D	Shelves	Vertical Grain	Horizontal Grain	List
				Model Number	Model Number	
16	36	12	1	X-LSWM163612	X-LSWM163612H	971
16	42	12	1	X-LSWM164212	X-LSWM164212H	995
16	48	12	1	X-LSWM164812	X-LSWM164812H	1,018
16	54	12	1	X-LSWM165412	X-LSWM165412H	1,043
16	60	12	1	X-LSWM166012	X-LSWM166012H	1,066
16	66	12	1	-	X-LSWM166612H	1,088
16	72	12	1	-	X-LSWM167212H	1,111

WALL MOUNTED L SHELVES						
H	W	D	Shelves	Vertical Grain	Horizontal Grain	List
				Model Number	Model Number	
45	36	12	2	X-LSWM453612	X-LSWM453612H	1,388
45	42	12	2	X-LSWM454212	X-LSWM454212H	1,421
45	48	12	2	X-LSWM454812	X-LSWM454812H	1,454
45	54	12	2	X-LSWM455412	X-LSWM455412H	1,488
45	60	12	2	X-LSWM456012	X-LSWM456012H	1,521
45	66	12	2	-	X-LSWM456612H	1,555
45	72	12	2	-	X-LSWM457212H	1,587



16" High

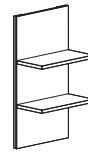

45" High

Specify

- Laminate Selection for Backboard
- Laminate Selection for Shelf

Notes

- Shelves have a max capacity of 10lbs per foot per width.
- Total thickness is 1 1/2". Backboard is mounted on 3/4" thick board finished in matching edge.
- Laminate grain for shelf always runs horizontal. Laminate grain for backboards are available in vertical and horizontal (not available in all sizes).
- L Shelves ship knocked down.
- Wall mounted laminate storage ships with a minimum of two MDF cleats depending on size. One cleat ships attached to the unit, and one cleat ships separately.
- Cleats are unfinished.

Wall Mounted Tackboards

WALL MOUNTED TACKBOARDS				
H	W	Model Number	List	Fabric Grade C
20	36	X-WMTACK2036	939	+27
20	42	X-WMTACK2042	954	+27
20	48	X-WMTACK2048	977	+27
20	54	X-WMTACK2054	1,001	+27
20	60	X-WMTACK2060	1,025	+27
20	66	X-WMTACK2066	1,050	+27
20	72	X-WMTACK2072	1,078	+27
28	36	X-WMTACK2836	995	+34
28	42	X-WMTACK2842	1,013	+34
28	48	X-WMTACK2848	1,031	+34
28	54	X-WMTACK2854	1,051	+34
28	60	X-WMTACK2860	1,069	+34
28	66	X-WMTACK2866	1,196	+34
28	72	X-WMTACK2872	1,234	+34

VERTICAL WALL MOUNTED TACKBOARD				
H	W	Model Number	List	Fabric Grade C
45	24	X-WMTACK4524	1,103	+34
45	30	X-WMTACK4530	1,123	+34
45	36	X-WMTACK4536	1,140	+34

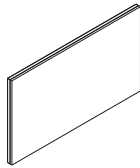

Specify

- Fabric Selection

Notes

- Tackboard thickness: 1 1/2".
- Fabric is applied horizontally (railroaded) on 61"H tackboards.

Standard Series Monitor Arms

SINGLE MONITOR ARM

Model Number	List
A-ERSMASB	526

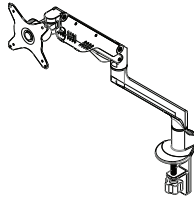

Notes

- Suitable for 10" - 28" size range LCD screens.
- Load capacity of 19lbs per arm.
- Features 180 degree rotation at the mounting base and extension.
- VESA monitor mount for 75mm and 100mm standard.
- Available mounting options include c-clamp, grommet or bolt through.
- Available in silver only.
- Single monitor arm features a snap-in/removable cord clip for wire management.
- Single monitor arm features a lock-in-place monitor mount for simplified installation.

DUAL MONITOR ARM

Model Number	List
A-ERDMASB	894

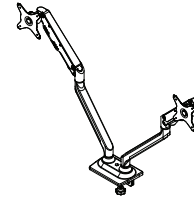

Notes

- Suitable for 10" - 28" size range LCD screens.
- Load capacity of 19 lbs per arm.
- Features 180 degree rotation at the mounting base and extension.
- VESA monitor mount for 75mm and 100mm standard.
- Available mounting options include c-clamp, grommet or bolt through.
- Available in silver only.
- Dual monitor arm features a lock-in-place monitor mount for simplified installation.

DUAL MONITOR ARM FOR SHALLOW DEPTH WORKSURFACES

Model Number	List
A-ERDMAM9	894

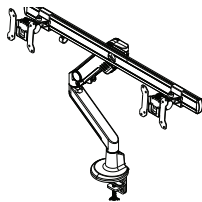

Notes

- Suitable for LCD screens up to 27".
- Load capacity of 14.3 lbs. per monitor.
- Features 180 degree rotation at the mounting base and extension.
- Monitors mount with M4 screws to a VESA bracket.
- VESA monitor mount for 75mm and 100mm standard.
- Mounts with c-clamp on the table edge or through a grommet hole.
- Available in silver only.
- Shallow depth monitor arm does not include a lock-in-place monitor mount.

Surface Mounted Power, Overhead LED Task Lights

BELLA 1050 CLAMP

Mounting Type	Model Number	List
Clamp	E-BELLA1050-STT	1,032

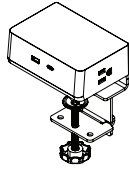

Clamp Mount

Specify

- Color (White or Black)

Notes

- Quick Charge (QC) & Power Delivery (PD) enabled
- 2 Tamper-Resistant AC outlets
- USB Type-A port: 5V-12V, Up to 18W; USB Type-C port: 5V-20V, Up to 45W
- 6' power cord

OVERHEAD LED TASK LIGHTS

Length	Model Number	List
24	A-LEDTL-61024	609
40	A-LEDTL-61540	904

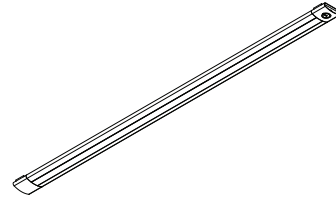

Notes

- LED task lights are 1-1/4" wide, and 3/8" in thickness and come in 24 and 40 inch lengths.
- Brushed aluminum with black trim.
- Attachable to the underside of overhead cabinet via the built-in magnets, or mounted to non-metal surfaces using the adjustable mounting bracket.
- Feature 100 lm/w with warm white and white color temps and convenient one-touch On/Off and Touch-and-Hold dimmer.
- Power-in and power-switch are reversible. Power cord is 10' in length.

Keyboard Arms, Mouse Trays, Pencil Drawers and Anti-Fatigue Mats

STANDARD EXTENDED KEYBOARD ARM

Model Number	List
A-KEYBZE	1,231

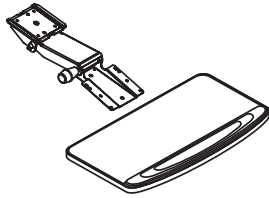

Notes

- Keyboard Arm / Trays mount to underside of worksurfaces to support standard computer keyboards.
- Keyboard platform area behind wrist rest measures 8 1/2" deep x 20" wide.
- All keyboard trays include a factory mounted, synthetic leather wrist rest.

STANDARD MOUSE TRAY

Model Number	List
A-MSETS	218

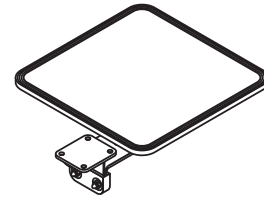

Notes

- Mouse Tray mounts to either the left or right side of keyboard tray platform with screws to service both left and right handed users.
- Mouse tray has standard mouse pad surface and requires no additional mouse pad.
- Mouse area measures 7 1/4" x 7 1/4".
- Mouse tray swivels around vertical axis 270° and has 30° of tilt around the horizontal axis (15° above keyboard tray plane to 15° below plane, independent of keyboard tray tilt).
- Order mouse tray separately.

PENCIL DRAWER

H	W	D	Model Number	List
2 1/4	21 1/4	16 1/4	A-PDRWP	318

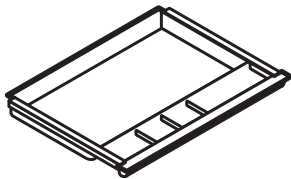

Notes

- Pencil Drawer provides convenient, low profile storage of loose items.
- Constructed of rigid, durable PVC with black textured finish.
- Plastic slides mount underneath worksurfaces with screws provided.
- Pencil drawer measures 16 1/4" deep x 21 1/4" wide x 2 1/4" high.
- Plan pencil drawer location around worksurface support elements.

ANTI-FATIGUE MAT

W	D	Thickness	Model Number	List
34	20	3/4	A-HF342075	259

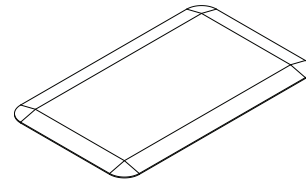

Notes

- Custom blended medium density polyurethane foam. High tear strength polyurethane outer membrane.
- Available in black only.

Lock Cores and Keys

SILVER LOCK CORES AND KEYS

Key Type	Model Number	List
Core with 2 keys	S-W1CORE1	25
Core with 2 keys (set of 2 keyed alike)	S-W1CORE2	39
Core with 2 keys (set of 3 keyed alike)	S-W1CORE3	60
Core with 2 keys (set of 4 keyed alike)	S-W1CORE4	77
Core with 2 keys (set of 5 keyed alike)	S-W1CORE5	95
Core with 2 keys (set of 6 keyed alike)	S-W1CORE6	111
Core with 2 keys (set of 7 keyed alike)	S-W1CORE7	129
Core with 2 keys (set of 8 keyed alike)	S-W1CORE8	149
Core with 2 keys (set of 9 keyed alike)	S-W1CORE9	166
Core with 2 keys (set of 10 keyed alike)	S-W1CORE10	184
Master Key	RS-W1MKEY	19
Core Removal Key	RS-W1CRKEY	19
Replacement Key	RS-WK __ _ (Key Number)	26

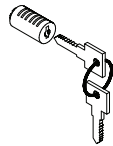

Notes

- Silver keyed alike lock cores should be specified when ordering Option E in the Lock Choice for Calibrate: No Lock w/ Silver Ring for Keyed Alike.
- Keyed alike lock cores must be installed in the field.
- Keys and Lock Cores are available in #'s 226 through 425.
- A core removal key is needed to remove an existing core from the lock housing in order to replace with a new core.
- Order sets based on quantity of storage items to be keyed alike.

BLACK LOCK CORES AND KEYS

Key Type	Model Number	List
Core with 2 keys	S-W1CORE1B	25
Core with 2 keys (set of 2 keyed alike)	S-W1CORE2B	39
Core with 2 keys (set of 3 keyed alike)	S-W1CORE3B	60
Core with 2 keys (set of 4 keyed alike)	S-W1CORE4B	77
Core with 2 keys (set of 5 keyed alike)	S-W1CORE5B	95
Core with 2 keys (set of 6 keyed alike)	S-W1CORE6B	111
Core with 2 keys (set of 7 keyed alike)	S-W1CORE7B	129
Core with 2 keys (set of 8 keyed alike)	S-W1CORE8B	149
Core with 2 keys (set of 9 keyed alike)	S-W1CORE9B	166
Core with 2 keys (set of 10 keyed alike)	S-W1CORE10B	184

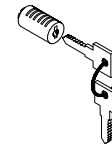

Notes

- Black keyed alike lock cores should be specified when ordering Option D in the Lock Choice for Calibrate: No Lock w/ Black Ring for Keyed Alike.
- Keyed alike lock cores must be installed in the field.
- Keys and Lock Cores are available in #'s 226 through 425.
- A core removal key is needed to remove an existing core from the lock housing in order to replace with a new core.
- Order sets based on quantity of storage items to be keyed alike.
- Black lock cores not available for L-Series storage.
- Black lock cores only available on laminate storage.



National Showrooms:

Leominster

AIS Headquarters
25 Tucker Drive
Leominster, MA 01453

Chicago

The Merchandise Mart
Suite 391
Chicago, Illinois 60654

New York

AIS New York
257 Park Avenue South
New York, New York 10010

Washington, D.C.

AIS Washington, D.C.
1501 M St, NW, STE 230
Washington, D.C. 20005

GSA Sales

GSA Contract 47QSM20D08Q4
Multiple Award Schedule (MAS)
Large Category: Furniture & Furnishings
Subcategories: Office Furniture, Packaged
Office Furniture and Furniture Services

For additional information on AIS:

Dealer Showrooms, Representative
Directory, Project Case Studies, Online
Catalog & Product Showcase
Visit: www.ais-inc.com